

GREASE DISTRIBUTION



GREASE DISTRIBUTION





GREASE DISTRIBUTION INDEX



AIR-OPERATED GREASE PUMPS pg. 003



AIR-OPERATED INDUSTRIAL GREASE PUMPS pg. 008



FRAME LIFTER-PRESS FOR GREASE pg. 013



AIR-OPERATED GREASE PUMPS SETS pg. 015



ACCESSORIES FOR AIR-OPERATED GREASE PUMPS pg. 023



NOZZLES FOR GREASE PUMPS pg. 025



PRESSURE REGULATORS pg. 028



MANUAL GREASE PUMPS pg. 029



ACCESSORIES FOR MANUAL GREASE PUMPS pg. 032



MANUAL GREASE PUMPS FOR GREASE TRANSFER pg. 033

The new air-operated grease pumps patented, fully designed and manufactured by MECLUBE, shows remarkable operating features. It is fully machined with electronic machine tools, the assembly is made with great care and the parts have been carefully tested in order to assure the best guarantee of reliability and a long life. The choice of materials and manufacturing quality make this pump suitable to work in the worst environmental conditions.

- **Brand new fully air operated motion reverse device, without cams and springs**
- **Reduced number of moving parts**
- **Big quantity of grease supplied at low air consumption**
- **High operating pressure**
- **Aluminum alloy body pump with electrolytic treatment that ensures very high corrosion strength**
- **High stressed elements in Fe 420 steel**





AIR-OPERATED GREASE PUMPS Mod. 660

COMPRESSION RATIO = 60:1

DELIVERY = 1600 g/min



Art. 010-1000-000

Air-operated grease pump ratio=60:1 Mod. 660
For standard drums 12-16 kg
(shank length 410 mm)
Polyurethane seals

Art. 010-1005-000

Air-operated grease pump ratio=60:1 Mod. 660
For standard drums 18-30 kg
(shank length 480 mm)
Polyurethane seals

Art. 010-1010-000

Air-operated grease pump ratio=60:1 Mod. 660
For standard drums 50-60 kg
(shank length 750 mm)
Polyurethane seals

Art. 010-1015-000

Air-operated grease pump ratio=60:1 Mod. 660
For standard barrels 180-220 kg
(shank length 950 mm)
Polyurethane seals



Art.	Kg	m ³	No.
010-1000-000	4,980	0,010	1
010-1005-000	5,240	0,010	1
010-1010-000	6,300	0,013	1
010-1015-000	7,100	0,016	1

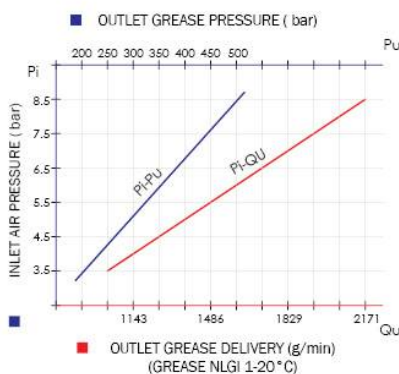
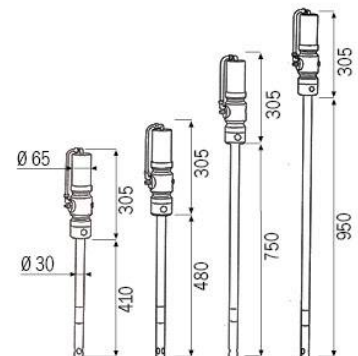

Technical data		010-1000-000	010-1005-000	010-1010-000	010-1015-000
Compression ratio		60:1	60:1	60:1	60:1
Max pressure feeding	bar	8	8	8	8
Air consumption medium	l/min	130	130	130	130
Air inlet connection	BSP	F 1/4" G	F 1/4" G	F 1/4" G	F 1/4" G
Grease outlet connection	BSP	M 1/4" G	M 1/4" G	M 1/4" G	M 1/4" G
Grease delivery capacity 6 bar	g/min	1600	1600	1600	1600
Noise	dB	76	76	76	76
Shank diameter	mm	30	30	30	30
Shank length	mm	410	480	750	950
For drums with capacity of	kg	12-16	18-30	50-60	180-220

Those are suitable for the supply at high pressure of all kinds of grease at short and long distance.

The operating pressure of the grease pumps hereby may vary between a minimum of 2.5 bar and a maximum of 8 bar. In order to optimize the efficiency and the life of our air operated pumps, we recommend to use filtered and lubricated air.

AIR-OPERATED GREASE PUMPS Mod. 670

COMPRESSION RATIO = 70:1

DELIVERY = 1100 g/min



Art. 010-1018-000

Air-operated grease pump ratio=70:1 Mod. 670

For standard drums 12-16 kg

(shank length 410 mm)

Polyurethane seals

Art. 010-1020-000

Air-operated grease pump ratio=70:1 Mod. 670

For standard drums 18-30 kg

(shank length 480 mm)

Polyurethane seals

Art. 010-1025-000

Air-operated grease pump ratio=70:1 Mod. 670

For standard drums 50-60 kg

(shank length 750 mm)

Polyurethane seals

Art. 010-1030-000

Air-operated grease pump ratio=70:1 Mod. 670

For standard barrels 180-220 kg

(shank length 950 mm)

Polyurethane seals



GREASE DISTRIBUTION

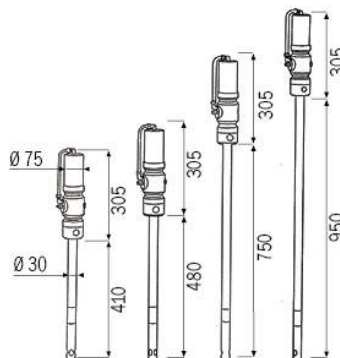

010-1018-000	5,160	0,010	1	
010-1020-000	5,460	0,010	1	
010-1025-000	6,370	0,013	1	
010-1030-000	7,100	0,016	1	

Technical data		010-1018-000	010-1020-000	010-1025-000	010-1030-000
Compression ratio		70:1	70:1	70:1	70:1
Max pressure feeding	bar	8	8	8	8
Air consumption medium	l/min	150	150	150	150
Air inlet connection	BSP	F 1/4" G	F 1/4" G	F 1/4" G	F 1/4" G
Grease outlet connection	BSP	M 1/4" G	M 1/4" G	M 1/4" G	M 1/4" G
Grease delivery capacity 6 bar	g/min	1100	1100	1100	1100
Noise	dB	76	76	76	76
Shank diameter	mm	30	30	30	30
Shank length	mm	410	480	750	950
For drums with capacity of	kg	12-16	18-30	50-60	180-220

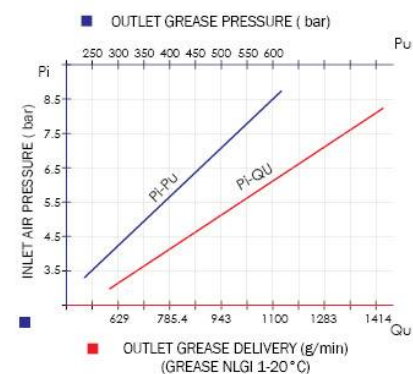

Those are suitable for central supply of plants where a major quantity of grease and a major pressure at long and short distance are required. The operating pressure of the grease pumps hereby may vary between a minimum of 2.5 bar and a maximum of 8 bar. In order to optimize the efficiency and the life of our pumps we recommend to use filtered and lubricated air.



AIR-OPERATED GREASE PUMPS Mod. 700

COMPRESSION RATIO = 100:1

DELIVERY = 1000 g/min



Art. 010-1032-000

Air-operated grease pump ratio=100:1 Mod. 700

For standard drums 18-30 kg

(shank length 480 mm)

Polyurethane seals

Art. 010-1034-000

Air-operated grease pump ratio=100:1 Mod. 700

For standard drums 50-60 kg

(shank length 750 mm)

Polyurethane seals

Art. 010-1035-000

Air-operated grease pump ratio=100:1 Mod. 700

For standard barrels 180-220 kg

(shank length 950 mm)

Polyurethane seals



Art. No.	Weight (Kg)	Volume (m³)	NF
010-1032-000	5,710	0,010	1
010-1034-000	6,670	0,013	1
010-1035-000	7,590	0,016	1

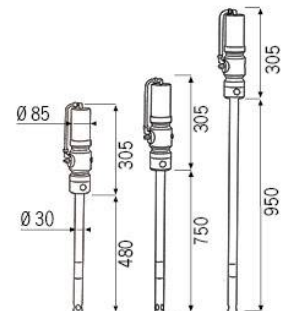

Technical data	010-1032-000	010-1034-000	010-1035-000
Compression ratio	100:1	100:1	100:1
Max pressure feeding	bar	8	8
Air consumption medium	l/min	190	190
Air inlet connection	BSP	F 1/4" G	F 1/4" G
Grease outlet connection	BSP	M 1/4" G	M 1/4" G
Grease delivery capacity 6 bar	g/min	1000	1000
Noise	dB	79	79
Shank diameter	mm	30	30
Shank length	mm	480	750
For drums with capacity of	kg	18-30	50-60
		180-220	

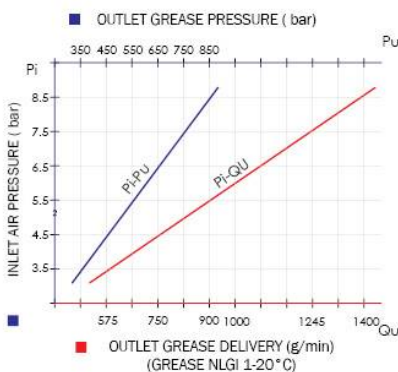

Those are suitable for central supply of plants where a major pressure at long and short distance is required. The operating pressure of the grease pumps hereby may vary between a minimum of 2.5 bar and a maximum of 8 bar. In order to optimize the efficiency and the life of our pneumatic pumps we recommend to use filtered and lubricated air.

AIR-OPERATED TRANSFER GREASE PUMPS Mod. 614

COMPRESSION RATIO = 14:1

DELIVERY = 2000 g/min



Art. 010-1036-000

Air-operated grease pump ratio=14:1 Mod. 614

For standard drums 18-30 kg

(shank length 480 mm)

Polyurethane seals

Art. 010-1038-000

Air-operated grease pump ratio=14:1 Mod. 614

For standard drums 50-60 kg

(shank length 740 mm)

Polyurethane seals

Art. 010-1040-000

Air-operated grease pump ratio=14:1 Mod. 614

For standard barrels 180-220 kg

(shank length 940 mm)

Polyurethane seals



GREASE DISTRIBUTION

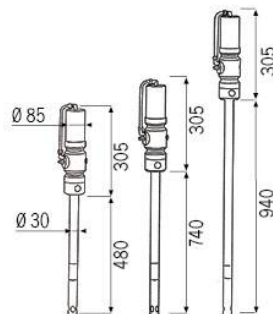

010-1036-000	5,310	0,010	1	
010-1038-000	5,960	0,013	1	
010-1040-000	6,610	0,016	1	

Technical data		010-1036-000	010-1038-000	010-1040-000
Compression ratio		14:1	14:1	14:1
Max pressure feeding	bar	8	8	8
Air consumption medium	l/min	220	220	220
Air inlet connection	BSP	F 1/4" G	F 1/4" G	F 1/4" G
Grease outlet connection	BSP	M 1/2" G	M 1/2" G	M 1/2" G
Grease delivery capacity 6 bar	g/min	2000	2000	2000
Noise	dB	80	80	80
Shank diameter	mm	30	30	30
Shank length	mm	480	740	940
For drums with capacity of	kg	18-30	50-60	180-220

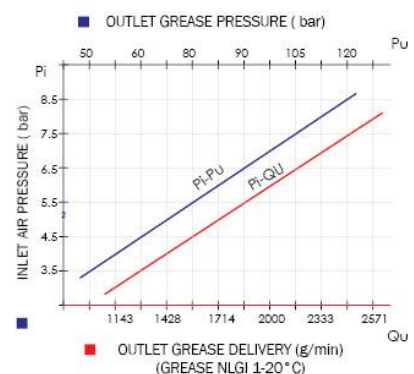

They are suitable for transferring a lot of types of grease, filling of central distribution plants, dispensers and manual pumps where a major quantity of grease with slow pressure and short distance is required. The operating pressure of the grease pumps hereby may vary between a minimum of 3.5 bar and a maximum of 8 bar. In order to optimize the efficiency and the life of our pneumatic pumps we recommend to use filtered and lubricated air.



INDUSTRIAL AIR OPERATED PUMPS

Meclube brand new industrial pumps, patented, fully designed and manufactured by Meclube, have remarkable practical features assuring high performances, both for what concerns the quantity and the use at high pressure.

The technical quality, the choice of materials and the treatments of tempering and grinding resulting in reduction of wear and make these pumps suitable to work reliable in the worst environmental conditions.

- **Brand new fully air operated motion reverse device, without cams and springs**
- **Reduced number of moving parts**
- **Big quantity of grease supplied at low air consumption**
- **High operating pressure**
- **Aluminium alloy body pump with electrolytic galvanized treatment that assures very high corrosion resistance**
- **High stressed part are from Fe 420 steel**



INDUSTRIAL AIR OPERATED PUMPS FOR GREASE AND VISCOUS MATERIALS Mod. 950 FLANGED

COMPRESSION RATIO = 50:1

DELIVERY = 4500 g/min



Art. 011-0950-050

Air operated industrial pump for grease ratio=50:1
 Mod. 950 flanged double effect
 For pump frame lifter-press and tanks (shank length 500 mm)
 Polyurethane seals
 For high viscosity grease and oils

Art. 011-0950-074

Air operated industrial pump for grease ratio=50:1
 Mod. 950 flanged double effect
 For drums 50-60 kg (shank length 740 mm)
 Polyurethane seals
 For high viscosity grease and oils

Art. 011-0950-094

Air operated industrial pump for grease ratio=50:1
 Mod. 950 flanged double effect
 For barrels 180-220 kg (shank length 940 mm)
 Polyurethane seals
 For high viscosity grease and oils



GREASE DISTRIBUTION

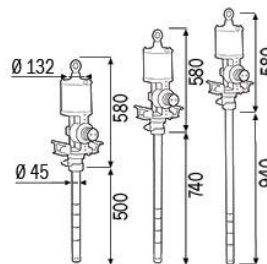

011-0950-050	18,500	0,045	1
011-0950-074	20,000	0,060	1
011-0950-094	21,000	0,070	1

Technical Data		011-0950-050	011-0950-074	011-0950-094
Compression ratio		50:1	50:1	50:1
Max pressure feeding	bar	8	8	8
Air consumption 8 bar	m ³ /min	1,75	1,75	1,75
Air inlet connection	BSP	F 1/2" G	F 1/2" G	F 1/2" G
Grease outlet connection	BSP	F 1/2" G	F 1/2" G	F 1/2" G
Grease delivery capacity 6 bar	g/min	4500	4500	4500
Noise	dB	80	80	80
Shank diameter	mm	45	45	45
Shank length	mm	500	740	940
For drums with capacity of	kg	PUMP LIFT/PRESS TANK	50-60	180-220

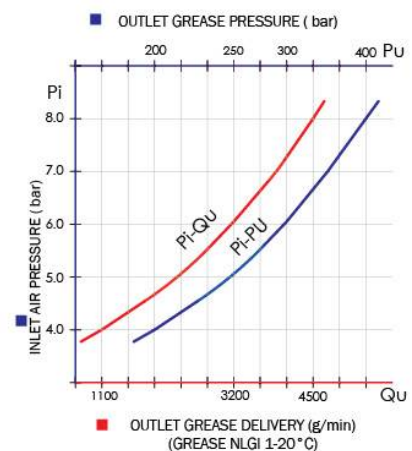

Suitable for high pressure transfer of high viscosity grease and fluids over short and long distances and for central distribution plants with multiple distribution points. The operating pressure of the pumps may vary between a minimum of 3 bar and a maximum of 8 bar. To optimize the efficiency and the live in time of our air operated pumps Meclube recommend to use filtered and lubricated air.



INDUSTRIAL AIR OPERATED PUMPS FOR GREASE AND VISCOUS MEDIAS Mod. 1275 FLANGED

COMPRESSION RATIO = 75:1

DELIVERY = 4500 g/min



Art. 011-1275-050

Air operated industrial pump for grease ratio=75:1
 Mod. 1275 flanged double effect
 For pump frame lift/press and tanks (shank length 500 mm)
 Polyurethane seals
 For high viscosity grease and oils

Art. 011-1275-074

Air operated industrial pump for grease ratio=75:1
 Mod. 1275 flanged double effect
 For drums 50-60 kg (shank length 740 mm)
 Polyurethane seals
 For high viscosity grease and oils

Art. 011-1275-094

Air operated industrial pump for grease ratio=75:1
 Mod. 1275 flanged double effect
 For barrels 180-220 kg (shank length 940 mm)
 Polyurethane seals
 For high viscosity grease and oils



011-1275-050	20,000	0,045	1
011-1275-074	22,000	0,060	1
011-1275-094	23,000	0,070	1

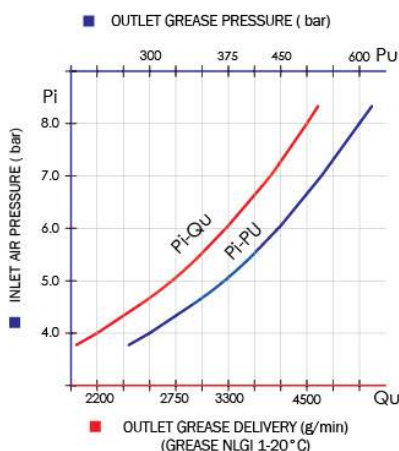
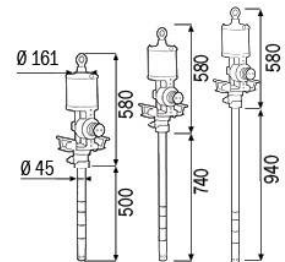

Technical Data		011-1275-050	011-1275-074	011-1275-094
Compression ratio		75:1	75:1	75:1
Max pressure feeding	bar	8	8	8
Air consumption 8 bar	m³/min	2,90	2,90	2,90
Air inlet connection	BSP	F 1/2" G	F 1/2" G	F 1/2" G
Grease outlet connection	BSP	F 1/2" G	F 1/2" G	F 1/2" G
Grease delivery capacity 6 bar	g/min	4500	4500	4500
Noise	dB	80	80	80
Shank diameter	mm	45	45	45
Shank length	mm	500	740	940
For drums with capacity of	kg	PUMP LIFT/PRESS TANK	50-60	180-220

Suitable for high pressure transfer of high viscosity grease and fluids over short and long distances and for central distribution plants with multiple distribution points.

The operating pressure of the pumps can vary between a minimum of 3 bar and a maximum of 8 bar. To optimize the efficiency and the live time of our air operated pumps we recommend to use filtered and lubricated air.

INDUSTRIAL AIR OPERATED PUMPS FOR GREASE AND VISCOUS MATERIALS Mod. 940 FLANGED

COMPRESSION RATIO = 40:1

DELIVERY = 10000 g/min



GREASE DISTRIBUTION

Art. 011-0940-060

Air operated industrial pump for grease ratio=40:1
 Mod. 940 flanged double effect
 For pump frame lift/press and tanks (shank length 600 mm)
 Polyurethane seals
 For high viscosity grease and oils

Art. 011-0940-074

Air operated industrial pump for grease ratio=40:1
 Mod. 940 flanged double effect
 For drums 50-60 kg (shank length 740 mm)
 Polyurethane seals
 For high viscosity grease and oils

Art. 011-0940-086

Air operated industrial pump for grease ratio=40:1
 Mod. 940 flanged double effect
 For tanks (shank length 860 mm)
 Polyurethane seals
 For high viscosity grease and oils

Art. 011-0940-094

Air operated industrial pump for grease R=40:1
 Mod. 940 flanged double effect
 For barrels 180-220 kg (shank length 940 mm)
 Polyurethane seals
 For high viscosity grease and oils

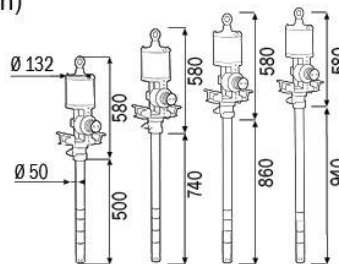

Art.	Weight (Kg)	Volume (m³)	Capacity (N)
011-0940-060	21,000	0,045	1
011-0940-074	23,000	0,060	1
011-0940-086	24,000	0,070	1
011-0940-094	25,000	0,070	1

Technical data		011-0940-060	011-0940-074	011-0940-086	011-0940-094
Compression ratio		40:1	40:1	40:1	40:1
Max pressure feeding	bar	8	8	8	8
Air consumption 8 bar	m³/min	1,75	1,75	1,75	1,75
Air inlet connection	BSP	F 1/2" G	F 1/2" G	F 1/2" G	F 1/2" G
Grease outlet connection	BSP	F 1/2" G	F 1/2" G	F 1/2" G	F 1/2" G
Grease delivery capacity 6 bar	g/min	10000	10000	10000	10000
Noise	dB	80	80	80	80
Shank diameter	mm	50	50	50	50
Shank length	mm	500	740	860	940
For drums with capacity of	kg	PUMP LIFT/ PRESS TANK	50-60	CISTERN	180-220

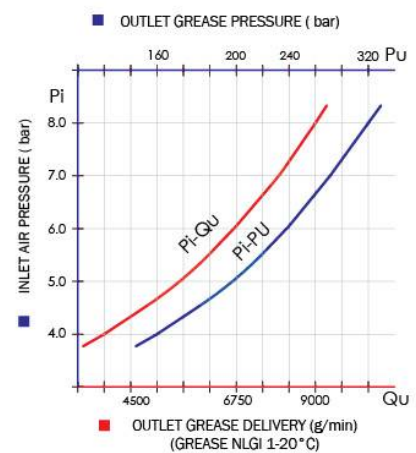

Suitable for high pressure transfer of high viscosity grease and fluids over short and long distances and for central distribution plants with multiple dispensing points.

The operating pressure of the pumps can vary between a minimum of 3 bar and a maximum of 8 bar. To optimize the efficiency and the live time of our air operated pumps we recommend to use filtered and lubricated air.



INDUSTRIAL AIR OPERATED PUMPS FOR GREASE AND VISCOUS MATERIAL Mod. 1270 FLANGED

COMPRESSION RATIO R=40:1

DELIVERY = 7000 g/min

Art. 011-1270-060

Air-operated industrial pump for grease R=40:1
 Mod. 1270 flanged double effect
 For frame lift-press and cisterns (shank length 600 mm)
 Polyurethane seals
 For high viscosity grease and oil

Art. 011-1270-074

Air-operated industrial pump for grease R=40:1
 Mod. 1270 flanged double effect
 For drums of 50-60 kg (shank length 740 mm)
 Polyurethane seals
 For high viscosity grease and oil

Art. 011-1270-086

Air-operated industrial pump for grease R=40:1
 Mod. 1270 flanged double effect
 For cisterns (shank length 860 mm)
 Polyurethane seals
 Per grassi e oli ad alta viscosità

Art. 011-1270-094

Air-operated industrial pump for grease R=40:1
 Mod. 1270 flanged double effect
 For barrels 180-220 kg (shank length 940 mm)
 Polyurethane seals
 For high viscosity grease and oil

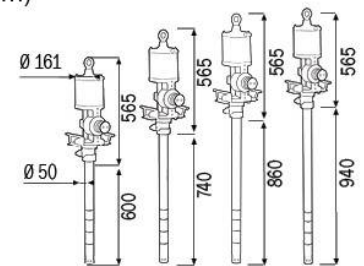

Model	Weight (Kg)	Volume (m³)	Air Consumption (N²)
011-1270-060	23,000	0,045	1
011-1270-074	25,000	0,060	1
011-1270-086	26,000	0,070	1
011-1270-094	27,000	0,070	1

Technical data		011-1270-060	011-1270-074	011-1270-086	011-1270-094
Compression ratio		70:1	70:1	70:1	70:1
Max pressure feeding	bar	8	8	8	8
Air consumption 8 bar	m³/min	2,90	2,90	2,90	2,90
Air inlet connection	BSP	F 1/2"G	F 1/2"G	F 1/2"G	F 1/2"G
Grease outlet connection	BSP	F 1/2"G	F 1/2"G	F 1/2"G	F 1/2"G
Grease delivery capacity 6 bar	g/min	7000	7000	7000	7000
Noise	dB	80	80	80	80
Shank diameter	mm	50	50	50	50
Shank length	mm	600	740	860	940
For drums with capacity of	kg	PUMP LIFT/ PRESS TANK	50-60	CISTERN	180-220

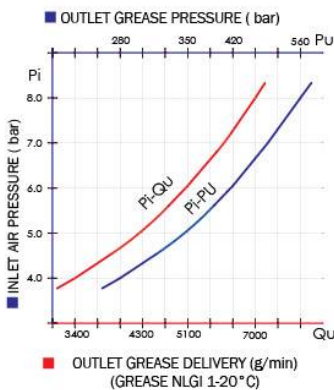

Suitable for high pressure transfer of high viscosity grease and fluids over short and long distances and for central distribution plants with multiple dispensing points.

The operating pressure of the pumps can vary between a minimum of 3 bar and a maximum of 8 bar. To optimize the efficiency and the live time of our air operated pumps we recommend to use filtered and lubricated air.

FRAME LIFTER-PRESS TO FIT PUMPS FOR GREASE AND VISCOUS MEDIAS



GREASE DISTRIBUTION

Art. 012-1200-030

Frame lifter-press for barrels 180-220 kg
Equipped with follower plate for grease pumps with shank Ø 30 mm

Art. 012-1200-045

Frame lifter-press for barrels 180-220 kg
Equipped with follower plate for grease pumps with shank Ø 45 mm

Art. 012-1200-050

Frame lifter-press for barrels 180-220 kg
Equipped with follower plate for grease pumps with shank Ø 50 mm

Art. 012-1200-200

Frame lifter-press for barrels 180-220 kg
Equipped with follower plate for grease pumps with shank F2" G



012-1200-045

Maximum height	Minimum height	Maximum pressure	Pushing power	For barrels	Viscosity
2802 mm	1802 mm	8 bar	4 bar - 450 kg 6 bar - 650 kg 8 bar - 870 kg	180 - 220 kg	200 - 500 ASTM (25°C)

012-1200-030	210,000	1,860	1	1
012-1200-045	210,000	1,860	1	1
012-1200-050	210,000	1,860	1	1
012-1200-200	210,000	1,860	1	1

Air operated two columns pumps lifter and press for grease and viscous medias.

With its particular 3 ways control valve it lifts or pull down the pump and the follower plate, improving the exchanging effort of 180-220kg (400 lbs) barrels.

It is particularly advised for the use with high viscosity grease and medias (from 200CPS to 500ASTM).

The follower plate is pushed down by the pressurised pneumatic cylinders, avoiding grease flow interruptions by air pockets in the grease bed.

Moreover, it allows to collect all the grease from the inner walls down to the bottom of the drum, Pump suction is assisted.

Aluminium follower plate with rubber double ring Ø 585mm
for barrels 180-220 kg

Art. 012-1250-030

with adaptor flange for Ø 30 mm shank (Art.012-1255-030)

Art. 012-1250-045

with adaptor flange for Ø 45 mm shank (Art.012-1255-045)

Art. 012-1250-050

with adaptor flange for Ø 50 mm shank (Art.012-1255-050)

Art. 012-1250-200

with adaptor flange for F 2" G shank (Art.012-1255-200)



012-1250-030	24,700	0,070	1	1
012-1250-045	24,700	0,070	1	1
012-1250-050	24,700	0,070	1	1
012-1250-200	24,700	0,070	1	1

Aluminium casted follower plate for grease and viscous medias with rubber double ring Ø 585mm for barrels 180-220 kg suitable for air operated grease pumps.
Equipped with ball valve, breather valve and adaptor.



COMPLETE KIT PUMP FRAME LIFTER-PRESS FOR GREASE AND VISCOUS MEDIAS



012-1350-000

Art. 012-1340-000

Kit pump frame lifter and press for grease for barrels 180-220 kg
Delivery 10 kg/min

Composed by:

Art.012-1200-050 Pump frame lifter and press 2 columns + follower plate

Art.011-0940-060 Industrial air operated pump ratio=40:1

Art.902-0302-010 Rubber hose R6 3/8" F-F 3/8" 1 m length

Art.902-0424-010 Rubber hose R6 1/2" F-F 1/2" 1 m length

Art. 012-1350-000

Kit pump frame lifter and press for grease for barrels 180-220 kg
Delivery 4,5 kg/min

Composed by:

Art.012-1200-045 Pump frame lifter and press 2 columns + follower plate

Art.011-0950-050 Industrial air operated pump ratio=50:1

Art.902-0302-010 Rubber hose R6 3/8" F-F 3/8" 1 m length

Art.902-0424-010 Rubber hose R6 1/2" F-F 1/2" 1 m length

Art. 012-1370-000

Kit pump frame lifter and press for grease for barrels 180-220 kg
Delivery 7,0 kg/min

Composed by:

Art.012-1200-050 Pump frame lifter and press 2 columns + follower plate

Art.011-1270-060 Industrial air operated pump ratio=70:1

Art.902-0302-010 Rubber hose R6 3/8" F-F 3/8" 1 m length

Art.902-0424-010 Rubber hose R6 1/2" F-F 1/2" 1 m length

Art. 012-1375-000

Kit pump frame lifter and press for grease for barrels 180-220 kg
Delivery 4,5 kg/min

Composed by:

Art.012-1200-045 Pump frame lifter and press 2 columns + follower plate

Art.011-1275-050 Industrial air operated pump ratio=75:1

Art.902-0302-010 Rubber hose R6 3/8" F-F 3/8" 1 m length

Art.902-0424-010 Rubber hose R6 1/2" F-F 1/2" 1 m length



012-1340-000	231,000	1,900	2
012-1350-000	228,500	1,900	2
012-1370-000	233,000	1,900	2
012-1375-000	230,000	1,900	2

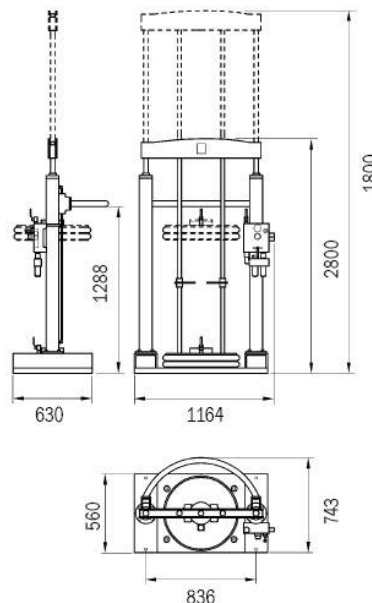
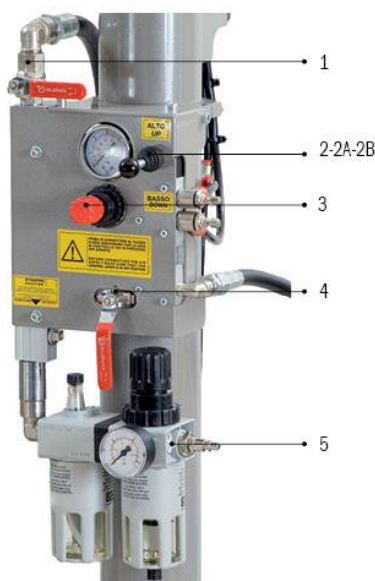

- 1 Cock feeding pump air
- 2 Off position
- 2A Lifting position up pump and follower plate
- 2B Acting position down press-fluid
- 3 Pressure regulator with manometer for feeding lifter air
- 4 Cock feeding air lifter follower plate
- 5 Inlet feeding general air into filter end lubricator

PNEUMATIC GREASE PUMP SETS FOR DRUMS 15-30 KG



Art. 013-1096-000

Pneumatic wheeled grease pump for 16 kg

Composed by:

Wheeled tank for 16 kg

Art.010-1000-000 Grease pump ratio=60:1

Art.014-1059-030 Follower plate Ø 220 mm

Art.907-0102-030 R2 1/4" hose - 3.0 m length

Art.014-1081-000 Grease gun with swivel joint

013-1096-00	17,800	0,010	2

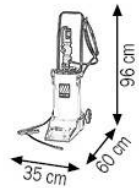

013-1096-000

Art. 013-1099-000

Grease set suitable for drums 15 Kg

Composed by:

Art.010-1000-000 Grease pump ratio=60:1

Art.014-1095-000 Handle

Art.014-1050-030 Lid Ø 280 mm

Art.014-1060-030 Follower plate Ø 265 mm

Art.907-0102-030 R2 1/4" hose - 3.0 m length

Art.014-1081-000 Grease gun with swivel joint

Art. 013-1098-000

Grease set suitable for drums 15 Kg

Composed like Art.013-1099-000 but without:

Art.014-1060-030 Follower plate Ø 265 mm

013-1099-000	11,160	0,056	1
013-1098-000	10,000	0,056	1

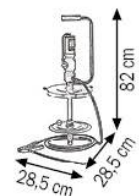
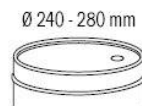

013-1099-000

Art. 013-1102-000

Grease set suitable for drums 18-30 Kg

Composed by:

Art.010-1005-000 Grease pump ratio=60:1

Art.014-1095-000 Handle

Art.014-1051-030 Lid Ø 320 mm

Art.014-1062-030 Follower plate Ø 310 mm

Art.907-0102-030 R2 1/4" hose - 3.0 m length

Art.014-1081-000 Grease gun with swivel joint

Art. 013-1100-000

Grease set suitable for drums 18-30 Kg

Composed like Art.013.1102.000 but without:

Art.014-1062-030 Follower plate Ø 310 mm

013-1102-000	11,870	0,056	1
013-1100-000	11,440	0,056	1



013-1102-000



PNEUMATIC GREASE PUMP SETS FOR DRUMS 50-220 KG



013-1103-000

Art. 013-1103-000

Grease set suitable for drums 50-60 kg

Composed by:

Art.010-1010-000 Grease pump ratio=60:1

Art.014-1054-030 Lid Ø 420 mm

Art.014-1065-030 Follower plate Ø 400 mm

Art.907-0102-030 R2 1/4" hose - 3.0 m length

Art.014-1081-000 Grease gun with swivel joint

Art. 013-1103-A00

Grease set suitable for drums 50-60 kg

Composed like Art.013-1103-000 but with:

Art.010-1025-000 Grease pump ratio=70:1

Art. 013-1103-B00

Grease set suitable for drums 50-60 kg

Composed like Art.013-1103-000 but with:

Art.010-1034-000 Grease pump ratio=100:1

Art. 013-1103-C00

Grease set suitable for drums 50-60 kg

Composed like Art.013-1103-000 but with:

Art.010-1038-000 Grease pump ratio=14:1



013-1103-000	12,630	0,079	1
013-1103-A00	13,000	0,079	1
013-1103-B00	13,000	0,079	1
013-1103-C00	13,000	0,079	1

Ø 370 - 420 mm

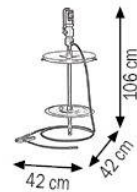

013-1104-000

Art. 013-1104-000

Grease set suitable for barrels 180-220 kg

Composed by:

Art.010-1015-000 Grease pump ratio=60:1

Art.014-1056-030 Lid Ø 600 mm

Art.014-1066-030 Follower plate Ø 590 mm

Art.907-0102-030 R2 1/4" hose - 3.0 m length

Art.014-1081-000 Grease gun with swivel joint

Art. 013-1104-A00

Grease set suitable for barrels 180-220 kg

Composed like Art.013-1104-000 but with:

Art.010-1030-000 Grease pump ratio=70:1

Art. 013-1104-B00

Grease set suitable for barrels 180-220 kg

Composed like Art.013-1104-000 but with:

Art.010-1035-000 Grease pump ratio=100:1

Art. 013-1104-C00

Grease set suitable for barrels 180-220 kg

Composed like Art.013-1104-000 but with:

Art.010-1040-000 Grease pump ratio=14:1



013-1104-000	15,500	0,088	2
013-1104-A00	15,870	0,088	2
013-1104-B00	15,870	0,088	2
013-1104-C00	15,870	0,088	2

Ø 550 - 600 mm



PNEUMATIC GREASE PUMP SETS FOR DRUMS 18-30 KG



Art. 013-1106-000

Wheeled grease set suitable for drums 18–30 kg

Composed by:

- Art.010-1005-000 Grease pump ratio=60:1
- Art.030-1392-000 2- wheels trolley
- Art.014-1051-030 Lid Ø 320 mm
- Art.014-1062-030 Follower plate Ø 310 mm
- Art.907-0102-030 R2 1/4" hose – 3.0 m length
- Art.014-1081-030 Grease gun with swivel joint

Art. 013-1105-000

Wheeled grease set suitable for drums 18–30 kg

Composed like Art.013.1106.000 but without:

- Art.014-1062-030 Follower plate Ø 310 mm

013-1106-000	15,740	0,056	1		Ø 260 - 320 mm
013-1105-000	14,310	0,056	1		

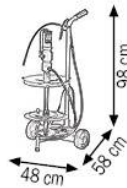

013-1106-000

Art. 013-1113-000

Wheeled grease set suitable for drums 18–30 kg

Composed by:

- Art.010-1005-000 Grease pump ratio=60:1
- Art.030-1392-000 2- wheels trolley
- Art.014-1052-030 Lid Ø 350 mm
- Art.014-1063-030 Follower plate Ø 340 mm
- Art.907-0102-030 R2 1/4" hose – 3.0 m length
- Art.014-1081-000 Grease gun with swivel joint

Art. 013-1112-000

Wheeled grease set suitable for drums 18–30 Kg

Composed like Art.013-1113-000 but without:

- Art.014-1063-030 Follower plate Ø 340 mm

013-1113-000	16,590	0,056	1		Ø 300 - 350 mm
013-1112-000	14,630	0,056	1		



013-1113-000

Art. 013-1108-000

Wheeled grease set suitable for drums 18–30 Kg

Composed by:

- Art.010-1005-000 Grease pump ratio=60:1
- Art.030-1393-000 2 pneumatic wheels trolley
- Art.014-1051-030 Lid Ø 320 mm
- Art.014-1062-030 Follower plate Ø 310 mm
- Art.907-0102-030 R2 1/4" hose – 3.0 m length
- Art.014-1081-000 Grease gun with swivel joint

Art. 013-1107-000

Wheeled grease set suitable for drums 18–30 Kg

Composed like Art.013-1108-000 but without:

- Art.014-1062-030 Follower plate Ø 310 mm

013-1108-000	18,000	0,056	1		Ø 260 - 320 mm
013-1107-000	16,670	0,056	1		



013-1108-000



PNEUMATIC GREASE PUMP SETS FOR DRUMS 50-60 KG



013-1118-000

Art. 013-1118-000

Wheeled grease set suitable for drums 50–60 kg

Composed by:

Art.010-1010-000 Grease pump ratio=60:1

Art.030-1394-000 2-pneumatic wheels trolley

Art.014-1053-030 Lid Ø 395 mm

Art.014-1064-030 Follower plate Ø 370 mm

Art.907-0102-030 R2 1/4" hose - 3.0 m length

Art.014-1081-000 Grease gun with swivel joint

Art. 013-1117-000

Wheeled grease set suitable for drums 50–60 kg

Composed like Art.013-1118-000 but without:

Art.014-1064-030 Follower plate Ø 370 mm



Ø 340 - 385 mm

013-1118-000	19,650	0,079	1
013-1117-000	17,470	0,079	1

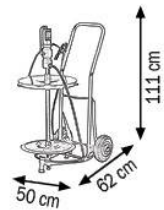

013-1116-000

Art. 013-1116-000

Wheeled grease set suitable for drums 50–60 kg

Composed by:

Art.010-1010-000 Grease pump ratio=60:1

Art.030-1394-000 2-pneumatic wheels trolley

Art.014-1054-030 Lid Ø 420 mm

Art.014-1065-030 Follower plate Ø 400 mm

Art.907-0102-030 R2 1/4" hose - 3.0 m length

Art.014-1081-000 Grease gun with swivel joint

Art. 013-1115-000

Wheeled grease set suitable for drums 50–60 kg

Composed like Art.013-1116-000 but without:

Art.014-1065-030 Follower plate Ø 400 mm



Ø 370 - 420 mm

013-1116-000	20,300	0,079	1
013-1115-000	17,800	0,079	1

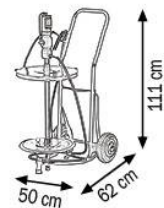

013-1120-000

Art. 013-1120-000

Wheeled grease set suitable for drums 50–60 kg

Composed by:

Art.010-1010-000 Grease pump ratio=60:1

Art.030-1395-000 4 - wheels trolley

Art.014-1054-030 Lid Ø 420 mm

Art.014-1065-030 Follower plate Ø 400 mm

Art.907-0102-050 R2 1/4" hose - 5.0 m length

Art.014-1081-000 Grease gun with swivel joint



Ø 370 - 420 mm

013-1120-000	26,800	0,079	1
--------------	--------	-------	---

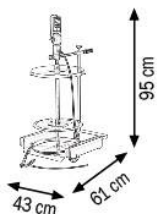

PNEUMATIC GREASE PUMP SETS FOR BARRELS 180-220 KG



Art. 013-1121-000

Wheeled grease set suitable for barrels 180–220 kg

Composed by:

- Art.010-1015-000 Grease pump ratio=60:1
- Art.030-1398-000 3-wheels trolley
- Art.014-1056-030 Lid Ø 600 mm
- Art.014-1066-030 Follower plate Ø 590 mm
- Art.907-0102-050 R2 1/4" hose – 5.0 m length
- Art.014-1081-000 Grease gun with swivel joint

013-1121-000	45,070	0,200	2

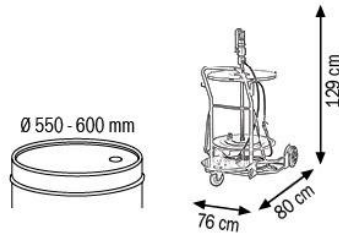

013-1121-000

Art. 013-1122-000

Wheeled grease set suitable for barrels 180–220 kg with hose reel

Composed by:

- Art.010-1015-000 Grease pump ratio=60:1
- Art.030-1398-000 3-wheels trolley
- Art.014-1056-030 Lid Ø 600 mm
- Art.014-1066-030 Follower plate Ø 590 mm
- Art.907-0122-015 R2 1/4" hose – 1.5 m length
- Art.014-1080-010 Gun with flexible pipe and fitting with triple-swivel joint
- Art.070-1207-110 Hose reel with R2 1/4" hose 10.0 m length

013-1122-000	56,900	0,246	3

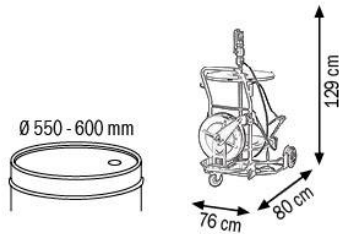

013-1122-000

Art. 013-1123-000

Wheeled grease set suitable for barrels 180–220 kg with hose reel

Composed by:

- Art.010-1030-000 Grease pump ratio=70:1
- Art.030-1398-000 3-wheels trolley
- Art.014-1056-030 Lid Ø 600 mm
- Art.014-1066-030 Follower plate Ø 590 mm
- Art.907-0122-015 R2 1/4" hose – 1.5 m length
- Art.014-1080-010 Gun with flexible pipe and fitting with triple-swivel joint
- Art.070-1307-118 Hose reel with R2 1/4" hose 18.0 m length

013-1123-000	66,700	0,246	3

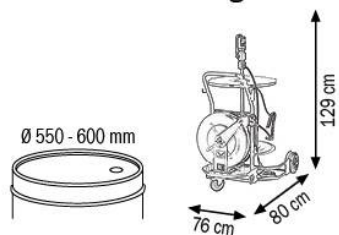

013-1123-000



PNEUMATIC GREASE PUMP SETS FOR BARRELS 180-220 KG



013-1125-000

Art. 013-1125-000

Wheeled grease set suitable for barrels 180–220 kg

Composed by:

Art.010-1015-000 Grease pump ratio=60:1

Art.030-1400-000 4-wheels trolley

Art.014-1056-030 Lid Ø 600 mm

Art.014-1066-030 Follower plate Ø 590 mm

Art.907-0102-050 R2 1/4" hose – 5.0 m length

Art.014-1081-000 Grease gun with swivel joint

013-1125-000	55,780	0,200	2

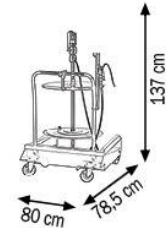

013-1130-000

Art. 013-1130-000

Wheeled grease set suitable for barrels 180–220 kg

Composed by:

Art.010-1015-000 Grease pump ratio=60:1

Art.030-1405-000 4-wheels trolley

Art.014-1056-030 Lid Ø 600 mm

Art.014-1066-030 Follower plate Ø 590 mm

Art.907-0102-050 R2 1/4" hose – 5.0 m length

Art.014-1080-010 Gun with flexible pipe and fitting with triple-swivel joint

013-1130-000	67,680	0,200	2

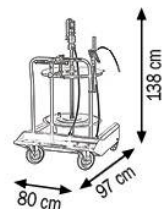

013-1135-000

Art. 013-1135-000

Wheeled grease set suitable for barrels 180–220 kg with hose reel

Composed by:

Art.010-1015-000 Grease pump ratio=60:1

Art.030-1405-000 4-wheels trolley

Art.014-1056-030 Lid Ø 600 mm

Art.014-1066-030 Follower plate Ø 590 mm

Art.907-0122-015 R2 1/4" hose – 1.5 m length

Art.014-1080-010 Gun with flexible pipe and fitting with triple-swivel joint

Art.070-1207-110 Hose reel with R2 1/4" hose 10.0 m length

013-1135-000	83,290	0,246	3

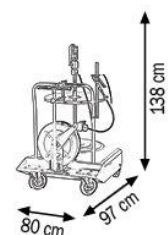
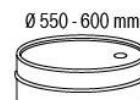

WALL-FIXING PNEUMATIC GREASE PUMP SETS



Art. 013-1136-000

Wall-fixing grease set suitable for drums 50–60 kg

Composed by:

- Art.010-1010-000 Grease pump ratio=60:1
- Art.071-1207-110 Hose reel with R2 1/4" hose 10,0 m length
- Art.014-1054-030 Lid Ø 420 mm
- Art.014-1065-030 Follower plate Ø 400 mm
- Art.907-0122-015 R2 1/4" hose - 1.5 m length
- Art.014-1080-010 Gun with flexible pipe and fitting with triple-swivel joint
- Art.079-1785-000 Support for picking up drops

Art. 013-1137-000

Wall-fixing grease set suitable for drums 50–60 kg

Composed like Art.013-1136-000 but with:

- Art.071-1207-215 Hose reel with R2 1/4" hose 15,0 m length



013-1136-000

013-1136-000	34,000	0,122	4	
013-1137-000	36,500	0,122	4	

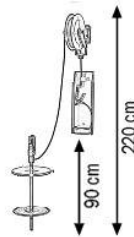

Art. 013-1138-000

Wall-fixing grease set suitable for barrels 180–220 kg

Composed by:

- Art.010-1015-000 Grease pump ratio=60:1
- Art.071-1207-110 Hose reel with R2 1/4" hose 10,0 m length
- Art.014-1056-030 Lid Ø 600 mm
- Art.014-1066-030 Follower plate Ø 590 mm
- Art.907-0122-015 R2 1/4" hose - 1.5 m length
- Art.014-1080-010 Gun with flexible pipe and fitting with triple-swivel joint
- Art.079-1785-000 Support for picking up drops

Art. 013-1139-000

Wall-fixing grease set suitable for barrels 180–220 Kg

Composed like Art.013-1138-000 but with:

- Art.071-1207-215 Hose reel with R2 1/4" hose 15,0 m length



013-1138-000

013-1138-000	40,860	0,151	4	
013-1139-000	42,700	0,151	4	

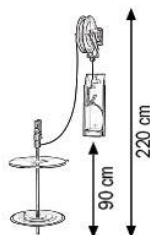



FIX INSTALLATION FOR GREASE DISTRIBUTION



013-1932-010

Art. 013-1932-010

Wall-fixing grease set suitable for barrels 180-220 kg

Composed by:

Art.010-1015-000 Grease pump ratio=60:1

Art.023-1905-000 Tank of dump and stocking for 1 barrel 180-220 kg

Art.075-4507-110 Hose reel with R2 1/4" hose 10,0 m length

Art.014-1056-030 Cover Ø 600 mm

Art.014-1066-030 Follower plate Ø 590 mm

Art.907-0122-015 R2 1/4" hose - 1.5 m length F-F

Art.014-1080-010 Gun with flexible pipe and fitting with triple-swivel joint

Art. 013-1932-015

Wall-fixing grease set suitable for barrels 180-220 kg

Composed like Art.013-1932-010 but with:

Art.075-4507-115 Hose reel with R2 1/4" hose 15,0 m length



013-1932-010	110,000	0,570	5
013-1932-015	112,000	0,570	5

Ø 370 - 420 mm

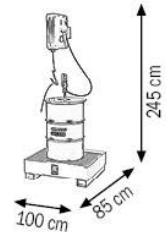

013-1933-010

Art. 013-1933-010

Complete installation 1 position for barrels 180-220 kg

Composed by:

Art.010-1015-000 Grease pump ratio=60:1

Art.023-1925-000 Tank of dump complete with supporting structure for 1 position

Art.075-4507-110 Hose reel with R2 1/4" hose 10,0 m length

Art.014-1056-030 Lid Ø 600 mm

Art.014-1066-030 Follower plate Ø 590 mm

Art.907-0122-015 R2 1/4" hose - 1.5 m length

Art.014-1080-010 Gun with flexible pipe and fitting with triple-swivel joint

Art. 013-1933-015

Complete installation 1 position for barrels 180-220 Kg

Composed like Art.013 1933 010 but with:

Art.075-4507-115 Hose reel with R2 1/4" hose 15,0 m length



013-1933-010	140,000	0,600	5
013-1933-015	142,000	0,600	5

Ø 370 - 420 mm

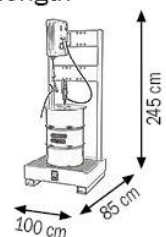

Fix and complete installation that offer an independent working station. They allow an optimal placing in every working environment (factories and repair shops) allowing to operate in a clean and safe way and without wasting of lubricant oils for different uses.

LID FOR PUMPS WITH SHANK Ø 30 mm

Art.	Ø Lid	For drums	outside Ø
014-1049-030	225 mm	5 Kg	200 - 225 mm
014-1050-030	280 mm	12 - 16 Kg	240 - 280 mm
014-1051-030	320 mm	18 - 30 Kg	260 - 320 mm
014-1052-030	350 mm	20 - 30 Kg	300 - 350 mm
014-1053-030	395 mm	30 - 50 Kg	340 - 395 mm
014-1054-030	420 mm	50 - 60 Kg	370 - 420 mm
014-1056-030	600 mm	180 - 220 Kg	550 - 600 mm



LID FOR INDUSTRIAL PUMPS WITH SHANK Ø 45 mm

Art.	Ø Lid	For drums	outside Ø
014-1053-045	395 mm	30-50 Kg	340-395 mm
014-1054-045	420 mm	50-60 Kg	370-420 mm
014-1056-045	600 mm	180-220 Kg	550-600 mm



LID FOR INDUSTRIAL PUMPS WITH SHANK Ø 50 mm

Art.	Ø Lid	For drums	outside Ø
014-1053-050	395 mm	30-50 Kg	340-395 mm
014-1054-050	420 mm	50-60 Kg	370-420 mm
014-1056-050	600 mm	180-220 Kg	550-600 mm



LID FOR INDUSTRIAL PUMPS WITH MUFF 2" F

Art.	Ø Lid	For drums	outside Ø
014-1053-200	395 mm	30-50 Kg	340-395 mm
014-1054-200	420 mm	50-60 Kg	370-420 mm
014-1056-200	600 mm	180-220 Kg	550-600 mm



Suitable for the application of the threaded ring fixing pumps.

The drum lid is available in different diameters to fit drums from 5 to 220 kg . A handle provides an easy fit to the drum. It keeps the pump in vertical position in order to assure a perfect working.

FOLLOWER PLATE FOR PUMPS WITH SHANK Ø 30 mm



Art.	Ø Follower Plates	For drums	inside Ø
014-1059-030	220 mm	5 Kg	195 - 210 mm
014-1060-030	265 mm	12 - 16 Kg	240 - 260 mm
014-1061-030	290 mm	16 - 20 Kg	250 - 280 mm
014-1062-030	310 mm	18 - 30 Kg	270 - 300 mm
014-1063-030	340 mm	20 - 30 Kg	300 - 330 mm
014-1064-030	370 mm	30 - 50 Kg	335 - 360 mm
014-1065-030	400 mm	50 - 60 Kg	360 - 400 mm
014-1066-030	590 mm	180 - 220 Kg	540 - 580 mm

FOLLOWER PLATE FOR INDUSTRIAL PUMPS WITH SHANK Ø 45 mm



Art.	Ø Follower Plates	For drums	inside Ø
014-1064-045	370 mm	30-50 kg	335-360 mm
014-1065-045	400 mm	50-60 kg	360-400 mm
014-1066-045	590 mm	180-220 kg	540-580 mm

FOLLOWER PLATE FOR INDUSTRIAL PUMPS WITH SHANK Ø 50 mm



Art.	Ø Follower Plates	For drums	inside Ø
014-1064-050	370 mm	30-50 kg	335-360 mm
014-1065-050	400 mm	50-60 kg	360-400 mm
014-1066-050	590 mm	180-220 kg	540-580 mm

It is advisable to use always the follower plate, it is very important of ambient temperature is low and when high viscosity grease is used. Because of the depression created by the pump, the plate is attracted towards the bottom of the drum by atmospheric pressure. It pushing the grease into the pump and avoids air cavities. Also it removes the grease remaining on the walls down to the bottom of the drums.

Art. 014-1079-000

Grease control gun without pipe and coupling



014-1079-000

Art. 014-1082-000

Grease control gun with rigid pipe and 4-jaws coupling
Length rigid pipe 200 mm



014-1082-000

Art. 014-1083-000

Grease control gun with rigid pipe and 4-jaws coupling
Length rigid pipe 200 mm
Swivel joint F 1/4"



014-1083-000

Art. 014-1083-010

Grease control gun with rigid pipe and 4-jaws coupling
Length rigid pipe 200 mm
Triple-swivel joint F 1/4"



014-1083-010

Art. 014-1080-000

Grease control gun with flexible hose and 4-jaws coupling
Length flexible hose 400 mm



014-1080-000

Art. 014-1081-000

Grease control gun with flexible hose and 4-jaws coupling
Length flexible hose 400 mm
Swivel joint F 1/4"



014-1081-000

Art. 014-1081-010

Grease control gun with flexible hose and 4-jaws coupling
Length flexible hose 400 mm
Triple-swivel joint F 1/4"



014-1081-010

Art. 014-1085-000

400 mm flexible hose with
M 10 x1 mm thread



014-1085-000

Art. 014-1086-000

200 mm rigid pipe with
M 10x1 mm thread



014-1086-000

All grease guns are supplied for the connection of the swivel joint Art.014-1091-000 or the triple-swivel joint Art.014-1090-000.



DIGITAL GREASE METER AND PNEUMATIC GREASE NOZZLES



014-1084-000

Art. 014-1084-000

Grease digital meter

Equipped with two displays, one is for batch counting (zeroing) and the other one for total volumes (not zeroing) of the dispensed grease.

Art. 014-1084-100

Grease digital meter nozzle

Composed by:

digital meter 4 digits

triple-swivel joint

rigid end + 4 jaws coupling

Not approved for public use



014-1084-100

Technical data		014-1084-000	014-1084-100
Inlet connection	BSP	F 1/8"G	F 1/4"G
Outlet connection	BSP	F 1/8"G	F 10X1
Max working pressure	bar	500	500
Burst pressure	bar	1000	1000
Batch meter	digits	4	4
Totalizing meter in kg	digits	4	4
Working temperature	max C°	60°	60°
Battery life	months	24	24



014-1042-000

Art. 014-1042-000

Pneumatic nozzle for grease ratio=50:1

500 cc with rigid pipe and jaws coupling

Suitable for Ø 52 mm 400 g cartridge

It is suitable for the distribution at high pressure of all kinds of grease.

The operating pressure for the grease pumps

hereby may vary between a minimum of 3.5 bar and a maximum of 8.5 bar

Technical data		014-1042-000
Compression ratio	bar	50:1
Air consumption	l/min	130
Air inlet connection	BSP	F 1/4"G
Grease outlet connection	M	F 10x1
Grease delivery capacity 6 bar	g/min	1500
Noise level	dB	80
Tank capacity	g	500
Inside diameter of chamber	mm	54
For cartridge Ø 52mm	g	400

Art. 014-1088-000

"PROFI" coupling with case-hardened jaws M 10x1 mm thread



014-1088-000



014-1088-A00

Art. 014-1088-A00

4-jaws coupling 10x1 mm 90° M 10x1 mm thread



014-1089-000



014-1089-A00

Art. 014-1089-000

Grease coupling-pull for hexagonal heads 15 mm M 10x1 mm thread

Art. 014-1089-A00

Grease coupling-push for hexagonal heads 15 mm M 10x1 mm thread

Art. 014-1089-B00

Giant grease coupling for hexagonal heads 22 mm M 10x1 mm thread



014-1089-B00

Art. 014-1090-000

Triple-swivel joint with 1/4" M-F thread

Art. 014-1091-000

1/4"-1/4" M-F swivel joint



F96-0502-002



F96-0500-002

Art. F96-0500-002

Quick connect coupling female 1/4" Interchange ability according to ISO 7241-A

Art. F96-0502-002

Quick connect coupling male 1/4" Interchange ability according to ISO 7241-A

Art. F96-0100-202

Plated steel M1/4"G - M1/4"G nipple



014-1091-000



014-1090-000

Art. F96-0100-303

Plated steel M3/8"G - M3/8" G nipple

Art. F96-0100-302

Plated steel M3/8"G x M1/4"G nipple

Art. F96-0100-402

Plated steel M1/2"G x M1/4"G nipple

Art. F96-0110-202

Plated steel M1/4"G x M1/4"NPT nipple

Art. F96-0110-302

Plated steel M3/8"NPT x M1/4"G nipple

Art. 014-1095-000

Grease pump handle



014-1095-000



F96-0100-202



F96-0110-302

Connection flexible hoses

Art.	Characteristics	Pressure	Burst	Length
907-0122-015	R2 1/4" F - F	W.P.400 bar	1600 bar	1.5 m
907-0122-020	R2 1/4" F - F	W.P.400 bar	1600 bar	2.0 m
907-0102-030	R2 1/4" M - F	W.P.400 bar	1600 bar	3.0 m
907-0102-040	R2 1/4" M - F	W.P.400 bar	1600 bar	4.0 m
907-0102-050	R2 1/4" M - F	W.P.400 bar	1600 bar	5.0 m
907-0102-060	R2 1/4" M - F	W.P.400 bar	1600 bar	6.0 m
907-0102-075	R2 1/4" M - F	W.P.400 bar	1600 bar	7.5 m
907-0102-080	R2 1/4" M - F	W.P.400 bar	1600 bar	8.0 m
907-0323-015	R2 3/8" F - F	W.P.330 bar	1320 bar	1.5 m
907-0323-020	R2 3/8" F - F	W.P.330 bar	1320 bar	2 m
907-0303-030	R2 3/8" M - F	W.P.330 bar	1320 bar	3 m
907-0303-040	R2 3/8" M - F	W.P.330 bar	1320 bar	4 m
907-0303-050	R2 3/8" M - F	W.P.330 bar	1320 bar	5 m



907-0102-030



014-1045-000



014-1045-B00

Art. 014-1045-000

Pressure regulator with gauge

Inlet - outlet connection F 1/4"

Necessary when the air-operated plant doesn't include it

Art. 014-1045-B00

Pressure regulator with gauge

Inlet - outlet connection F 1/2"



014-1046-000



014-1046-B00

Art. 014-1046-000

Pressure regulator with filter and gauge

Inlet - outlet connection F 1/4"

It avoids condensation suitable when the use of the pump is continuative

Art. 014-1046-B00

Pressure regulator with filter and gauge

Inlet - outlet connection F 1/2"



014-1047-000



014-1047-B00

Art. 014-1047-000

Air lubricator Inlet - outlet connection F 1/4"

It sprays the lubricant optimising the efficiency and the life of the pump

Art. 014-1047-B00

Air lubricator Inlet - outlet connection F 1/2"



014-1048-000



014-1048-B00

Art. 014-1048-000

Pressure regulator with filter, lubricator and gauge

Inlet - outlet connection F 1/4"

Automatic outlet of condensation. It optimizes the working and life of pumps. When the pump is regularly used, it fully prevents the seizing-up of the moving part

Art. 014-1048-B00

Pressure regulator with filter, lubricator and gauge

Inlet - outlet connection F 1/2"

Automatic outlet of condensation

In order to optimize the efficiency and the life time of your air-operated equipment we recommend to use condensate and particle free air at the correct pressure and lubricated.



MOBILE MANUAL GREASE PUMPS POWERED BY LEVER

Practical and functional can be used in all the work environment, in particular on disconnected land as in agricultural or in construction site.

Grant you the easy substitution of the grease container (drum or bucket) and permit a quick greasing of every vehicle or mechanism. Are equipped with follower plate to maintain the pumps function and preserving its characteristics in use.



MOBILE MANUAL PUMPS FOR GREASE TRANSFER POWERED BY LEVER

Each cycles of the lever supply 40 gram of grease. Practical and functional can be used for the filling of digital unit dispensers, syringe for the manual greasing.

Grant you the easy substitution of the grease container (drum or bucket).

Are equipped with follower plate to maintain the pumps function and preserving its characteristics in use.



HIGH PRESSURE MANUAL GREASE PUMPS



016-1141-000

Art. 016-1141-000

Manual grease pump 16 kg

Outlet grease pressure 400 bar, 60 g delivery each 10 cycles of the lever

Composed by:

Mobile container 16 kg

Art.014-1059-030 Follower plate Ø 220 mm with spring

Art.906-0142-020 Rubber hose R1 F 1/4" - F 10X1 2.0 m length

Art.017-1155-000 Cock M-F 10x1 mm

Art.017-1156-000 200 mm rigid pipe and 4-jaws coupling

016-1141-000	12,850	0,090	1



016-1142-000

Art. 016-1142-000

Wheeled manual grease pump 16 kg

Outlet grease pressure 400 bar, 60 g delivery each 10 cycles of the lever

Composed by:

Wheeled container 16 kg

Art.014-1059-030 Follower plate Ø 220 mm with spring

Art.906-0142-020 Rubber hose R1 F 1/4" - F 10X1 2.0 m length

Art.017-1155-000 Cock M-F 10x1 mm

Art.017-1156-000 200 mm rigid pipe and 4-jaws coupling

016-1142-000	14,300	0,090	1

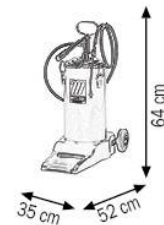

016-1144-000

Art. 016-1144-000

Wheeled manual grease pedal pump 16 kg

Outlet grease pressure 400 bar, 40 g delivery each 10 cycles of the lever

Composed by:

Wheeled container 16 kg

Art.014-1059-030 Follower plate Ø 220 mm with spring

Art.906-0142-020 Rubber hose R1 F 1/4" - F 10X1 2.0 m length

Art.017-1155-000 Cock M-F 10x1 mm

Art.017-1156-000 200 mm rigid pipe and 4-jaws coupling

016-1144-000	16,600	0,090	1

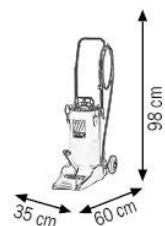

Art. 016-1145-015

Manual grease pump for drums of 15 kg

Outlet grease pressure 400 bar, 60 g delivery each 10 cycles of the lever

Composed by

Art.016-1158-000 Manual grease pump

Art.014-1050-030 Ø 280 mm drum lid

Art.014-1060-030 Follower plate Ø 265mm with spring

Art.906-0142-020 Rubber hose R1 F 1/4" - F 10X1 2.0 m length

Art.017-1155-000 Cock M-F 10x1mm

Art.017-1156-000 200 mm rigid pipe and 4-jaws coupling



016-1145-015

Art. 016-1145-C15

Wheeled manual grease pump for drums of 15 kg

Outlet grease pressure 400 bar, 60 g delivery each 10 cycles of the lever

Composed by:

Art.016-1158-000 Manual grease pump

Art.030-1392-000 2 wheels trolley

Art.014-1050-030 Ø 280 mm drum lid

Art.014-1060-030 Follower plate Ø 265mm with spring





Art.906-0142-020 Rubber hose R1 F 1/4" - F 10X1 2.0 m length

Art.017-1155-000 Cock M-F 10x1mm

Art.017-1156-000 200 mm rigid pipe and 4-jaws coupling



016-1145-C15

				
016-1145-015	6,100	0,023	1	
016-1145-C15	11,250	0,056	1	

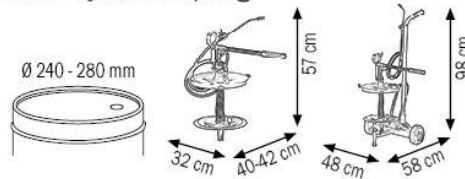

Art. 016-1150-020

Manual grease pump for drums of 18-30 Kg

Outlet grease pressure 400 bar, 60 g delivery each 10 cycles of the lever

Composed by:

Art.016-1158-000 Manual grease pump

Art.014-1051-030 Ø 320 mm drum lid

Art.014-1062-030 Follower plate Ø 310mm with spring

Art.906-0142-020 Rubber hose R1 F 1/4" - F 10X1 2.0 m length

Art.017-1155-000 Cock M-F 10x1mm

Art.017-1156-000 200 mm rigid pipe and 4-jaws coupling



016-1150-020

Art. 016-1150-C20

Wheeled manual grease pump for drums of 18-30 kg

Outlet grease pressure 400 bar, 60 g delivery each 10 cycles of the lever

Composed by:

Art.016-1158-000 Manual grease pump

Art.030-1392-000 2 wheels trolley

Art.014-1051-030 Ø 320 mm drum lid

Art.014-1062-030 Follower plate Ø 310mm with spring





Art.906-0142-020 Rubber hose R1 F 1/4" - F 10X1 2.0 m length

Art.017-1155-000 Cock M-F 10x1mm

Art.017-1156-000 200 mm rigid pipe and 4-jaws fitting



016-1150-C20

				
016-1150-020	6,550	0,023	1	
016-1150-C20	17,750	0,056	1	

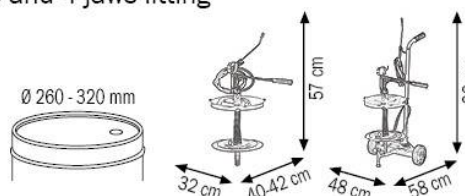



HIGH PRESSURE MANUAL GREASE PUMPS



016-1150-050

Art. 016-1150-050

Manual grease pump for drums of 50-60 kg.

Outlet grease pressure 400 bar, 60 g delivery each 10 cycles of the lever

Composed by:

Art.016-1158-A00 Manual grease pump

Art.014-1054-030 Ø 420 mm drum lid

Art.014-1065-030 Follower plate Ø 400mm with spring

Art.906-0142-020 Rubber hose R1 F 1/4" - F 10X1 2.0 m length

Art.017-1155-000 Cock M-F 10x1mm

Art.017-1156-000 200 mm rigid pipe and 4-jaws coupling



016-1150-C50

Art. 016-1150-C50

Wheeled manual grease pump for drums of 50-60 kg

Outlet grease pressure 400 bar, 60 g delivery each 10 cycles of the lever

Composed by:

Art.016-1158-A00 Manual grease pump

Art.030-1395 000 4 wheels trolley

Art.014-1054-030 Ø 420 mm drum lid

Art.014-1065-030 Follower plate Ø 400mm with spring

Art.906-0142-020 Rubber hose R1 F 1/4" - F 10X1 2.0 m length

Art.017-1155-000 Cock M-F 10x1mm

Art.017-1156-000 200 mm rigid pipe and 4-jaws coupling

016-1150-050		10,800	0,056	1		Ø 370 - 420 mm	42 cm	94 cm
016-1150-C50		22,800	0,056	1			40-42 cm	98 cm

ACCESSORIES FOR MANUAL GREASE PUMPS



017-1155-000

Art. 017-1155-000

Brass cock

with M-F 10x1 mm thread



017-1156-000

Art. 017-1156-000

200 mm rigid pipe

4-jaws fitting with 10x1 mm thread



017-1157-000

Art. 017-1157-000

4-jaws fitting

10x1 mm thread



017-1161-000

Art. 017-1161-000

90° Rigid connection with adaptor Ø 9 mm

for manual grease pumps filling



906-1220-030

Art. 906-0142-020

Rubber hose R1 1/4"

F 1/4" - F 10x1 - 2.0 m length

Art. 906-0142-030

Rubber hose R1 1/4"

F 1/4" - F 10x1 - 3.0 m length

Art. 016-1151-020

Manual transfer grease pump for drums of 18-30 kg
Suitable for filling manual grease pumps, 400 g delivery each 10 cycles of the lever

Composed by:

- Art.016-1160-020 Manual transfer pump
- Art.014-1051-030 Ø 320 mm drum lid
- Art.014-1062-030 Follower plate Ø 310mm with spring
- Art.017-1161-000 Rigid connection 90° with adaptor Ø 9 mm



016-1151-020

Art. 016-1151-C20

Wheeled manual transfer grease pump for drums of 18-30 kg
Suitable for filling manual grease pumps, 400 g delivery each 10 cycles of the lever

Composed by:

- Art.016-1160-020 Manual transfer pump
- Art.030-1392-000 2 wheels trolley
- Art.014-1051-030 Ø 320 mm drum lid
- Art.014-1062-030 Follower plate Ø 310mm with spring
- Art.017-1161-000 Rigid connection 90° with adaptor Ø 9 mm



016-1151-C20

016-1151-020	6,350	0,023	1	
016-1151-C20	11.500	0,056	1	

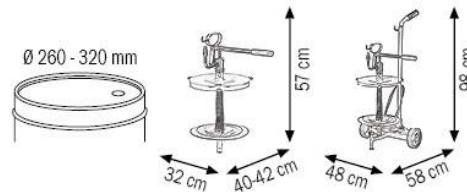

Art. 016-1151-050

Manual transfer grease pump for drums of 50-60 kg
Suitable for filling manual grease pumps, 400 g delivery each 10 cycles of the lever

Composed by:

- Art.016-1160-050 Manual transfer pump
- Art.014-1054-030 Ø 420 mm drum lid
- Art.014-1065-030 Follower plate Ø 400mm with spring
- Art.017-1161-000 Rigid connection 90° with adaptor Ø 9 mm



016-1151-050

Art. 016-1151-C50

Wheeled manual transfer grease pump for drums of 50-60 kg
Suitable for filling manual grease pumps, 400 g delivery each 10 cycles of the lever

Composed by:

- Art.016-1160-050 Manual transfer pump
- Art.030-1395-000 4 wheels trolley
- Art.014-1054-030 Ø 420 mm drum lid
- Art.014-1065-030 Follower plate Ø 400mm with spring
- Art.017-1161-000 Rigid connection 90° with adaptor Ø 9 mm



016-1151-C50

016-1151-050	10,700	0,790	1	
016-1151-C50	21.800	0,790	1	

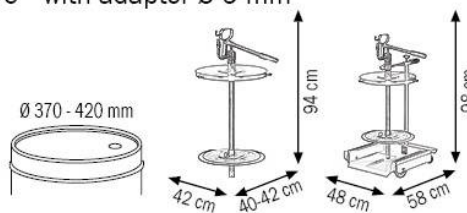



016-1152-020

Art. 016-1152-020

Manual transfer grease pump for drums of 18-30 kg
Suitable for filling plants, 400 g delivery each 10 cycles of the lever
Composed by:

- Art.016-1160-020 Manual transfer pump
- Art.014-1051-030 Ø 320 mm drum lid
- Art.014-1062-030 Follower plate Ø 310mm with spring
- Art.902-0414-020 R6 1/2" hose 2.0 m length
with level valve rigid end 30°
- Art.F96-0500-002 Quick disconnect coupling F 1/4"
- Art.F96-0502-002 Quick disconnect coupling M 1/4"



016-1152-C20

Art. 016-1152-C20

Wheeled manual transfer grease pump for drums of 18-30 kg
Suitable for filling plants, 400 g delivery each 10 cycles of the lever
Composed by:

- Art.016-1160-020 Manual transfer pump
- Art.030-1392-000 2 wheels trolley
- Art.014-1051-030 Ø 320 mm drum lid
- Art.014-1062-030 Follower plate Ø 310mm with spring
- Art.902-0414-020 R6 1/2" hose 2.0 m length
with level valve rigid end 30°
- Art.F96-0500-002 Quick disconnect coupling F 1/4"
- Art.F96-0502-002 Quick disconnect coupling M 1/4"



016-1152-050

Art. 016-1152-050

Manual transfer grease pump for drums of 50-60 kg
Suitable for filling plants, 400 g delivery each 10 cycles of the lever
Composed by:

- Art.016-1160-050 Manual transfer pump
- Art.014-1054-030 Ø 420 mm drum lid
- Art.014-1065-030 Follower plate Ø 400mm with spring
- Art.902-0414-020 R6 1/2" hose 2.0 m length
with level valve rigid end 30°
- Art.F96-0500-002 Quick disconnect coupling F 1/4"
- Art.F96-0502-002 Quick disconnect coupling M 1/4"



016-1152-C50

Art. 016-1152-C50

Wheeled manual transfer grease pump for drums of 50-60 kg
Suitable for filling plants, 400 g delivery each 10 cycles of the lever
Composed by:

- Art.016-1160-050 Manual transfer pump
- Art.030-1395-000 4 wheels trolley
- Art.014-1054-030 Ø 420 mm drum lid
- Art.014-1065-030 Follower plate Ø 400mm with spring
- Art.902-0414-020 R6 1/2" hose 2.0 m length
with level valve rigid end 30°
- Art.F96-0500-002 Quick disconnect coupling F 1/4"
- Art.F96-0502-002 Quick disconnect coupling M 1/4"



Ø 260 - 320 mm

016-1152-020	7,400	0,023	1
016-1152-C20	12,500	0,056	1

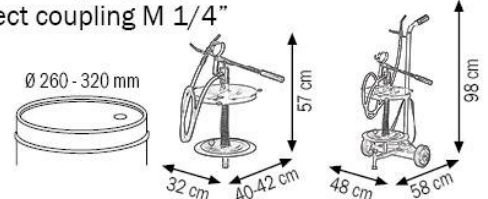

Ø 370 - 420 mm

016-1152-050	11,700	0,790	1
016-1152-C50	22,800	0,790	1

